

# INDUSTRIAL

## SITE LIGHT

Tel:+86-571-87114761  
Fax:+86-571-87114571  
Email:sales@lucoh.com  
Web: <http://www.lucoh.com>

Production Base 1: 5-1 Lingyun Road, Sandu Industrial Park, Jiande City, Hangzhou, Zhejiang Province  
Production Base 2: No.5 Xinxing Road, Ninghai County, Ningbo City, Zhejiang Province  
Headquarter: Room 1202, Building A2, Qimeng Science and Technology Park, No.1899 Gudun Road, Liangzhu Street, Yuhang District, Hangzhou, Zhejiang, China

SAUDAÇÕES AOS TRABALHADORES QUE TRABALHAM NO ESCURO

ODM&OEM Cooperation welcomed  
More Than 10 Years Experience For Rechargeable LED Lighting Products

**LUCOH**





## SOBRE A EMPRESA

Hangzhou Lucoh Lighting Technology Co., Ltd. foi fundada em outubro de 2012 e é uma empresa de tecnologia inovadora que integra design e desenvolvimento, fabricação e exportação de luzes industriais recarregáveis para locais de trabalho. Em 2020, recebemos o título de empresa nacional de alta tecnologia. A Lucoh Lighting está atualmente fazendo negócios principalmente no Japão na Ásia, no Reino Unido e na Alemanha na Europa, bem como na Austrália e nos Estados Unidos e no Canadá na América do Norte. Temos cooperação ODM e OEM com marcas conhecidas nessas regiões e países. Em 2020, passamos a comercializar também os produtos com marcas próprias. LU-COH na China e LUXROVER na América.

Com base em nossa rica experiência e capacidade de P&D bem conhecida, iniciamos a iluminação pública solar em 2017 conforme solicitado pelos clientes. E em 2021, dividimos este negócio da Lucoh Lighting e estabelecemos uma nova empresa Solarace New Energy para desenvolver luzes solares, energia de armazenamento industrial, postes de inteligência e outros novos produtos de energia. Nos primeiros anos do estabelecimento, o projeto da Quzhou Union Avenue de postes inteligentes liderados pela Iron Construction foi produzido, instalado por nós e amplamente elogiado por clientes e proprietários.

As sedes das duas empresas estão em Hangzhou e construímos fábricas diferentes para cada marca para fabricar os produtos. Um está localizado em Jiande para os produtos da LUCOH. Outro está localizado em Ninghai para os produtos da SOLARACE. A fim de controlar melhor a qualidade do produto, investimos em uma fábrica de baterias em Hangzhou em 2023 para fornecer baterias e testes relacionados para todos os produtos.









# SISTEMA DE BATERIA CIII



# ADAPTADORES DE TRANSFORMAÇÃO



MULTI ADAPTADOR	BATERIA CORRESPONDENTE
TJ-4 1	PANASONIC, HIKOKI, MAKITA, BOSCH
TU-3 1	MILWAUKEE, METABO, DEWALT
TA-3 1	MILWAUKEE, DEWALT
TE-4 1	EINHELL, PARKSIDE, FLEX, FESTOOL



**VORTEX**





# SÉRIES VORTEX

80W



40W



## VORTEX-80W

**P** 80W

**L** 10000lm

**IP** IP65

## VORTEX-80W

**P** 40W

**L** 5000lm

**IP** IP65

RA

>80

SAIDA USB

5V, 2A

BATERIA

19.2V 6.0Ah LiFePO4

TEMPO DE RECARGA

1.5-2H (pacote 21.6V 4A AC)

MODO DE TRABALHO

20%-40%-60%-80%-100%

Swich: ON/OFF

TEMPO DE TRABALHO

80W: 1-2H (100%)

8-9H (100%)

40W: 3-4H (100%)

13-14H (20%)

MATERIAL

Cast aluminium/PC/ABS

CCT

5000K (Optional)

ÂNGULO DE FEIXE

120°

TAMANHO

80W: 267\*147\*360mm

40W: 267\*147\*291mm

### Gancho & Tripé

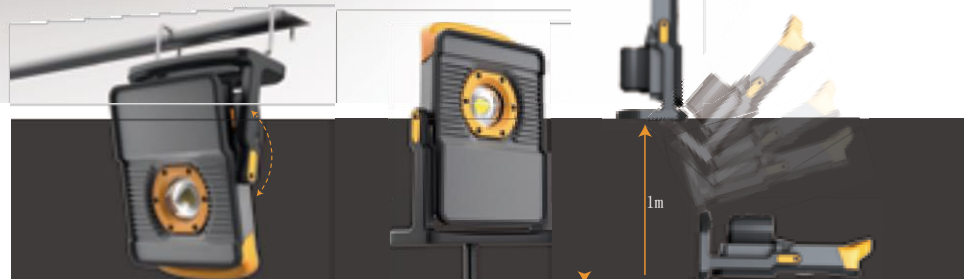

### Pacote AC

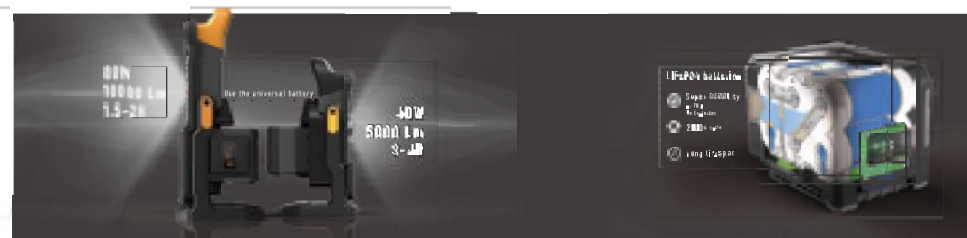

# SÉRIES VORTEX

## VORTEX-20W

**P** 20W

**L** 10000lm

**IP** IP65 (sem bateria de ferramenta)

RA

70

SAIDA USB

Max 5V, 1A

MODO DE TRABALHO

20%-50%-100%-OFF

CCT

4000K (Optional)

ÂNGULO DE FEIXE

60°

ADAPTADOR

Input: AC 100-240V Output: DC 12V 2A



## 11 Marcas de baterias de ferramentas disponíveis (14.4V/18V)





# BAYMAX





60W



30W



**BAYMAX-DESTACÁVEL-30W**

30W   
5000LM   
IP65

**BAYMAX-DESTACÁVEL-60W**

60W   
8000LM   
IP65

RA  
>70

**BATERIA**

19.2V 6.0Ah LiFePO4

**TEMPO DE RECARGA**

1.5-2H (pacote 21.6V 4A AC)

**MODO DE TRABALHO**

100%-50%-OFF

**TEMPO DE DURAÇÃO**

30W: 4-5H (100%) / 7-8H (50%)

60W: 2-3H (100%) / 5-6H (50%)

**MATERIAL**

Cast aluminium/PC/ABS

**CCT**

6000K (Optional)

**ÂNGULO DO FEIXE**

120°

**TAMANHO**

30W: 312\*230\*334mm

60W: 312\*230\*334mm

**ATRÁS**



**( BATERIA DESTACÁVEL )**



**Características**

**Gancho**



Rotativo

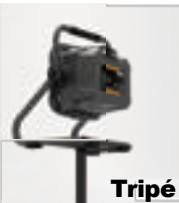

Tripé



Rotativo

**Pacote AC**



CARREGADOR



ALIMENTADOR AC



CARREGANDO ENQUANTO ILUMINA

60W



30W



**BAYMAX-FIXO-30W**

30W   
5000LM   
IP65

**BAYMAX-FIXO-30W**

60W   
8000LM   
IP65

RA  
>70

**BATERIA**

30W: 12.8V 16AH 205Wh

60W: 12.8V 20Ah 256Wh

**TEMPO DE RECARGA**

30W: 5-6H

60W: 9-10H

**MODO DE TRABALHO**

20%-40%-60%-80%-100%

Swich: ON/OFF

**TEMPO DE DURAÇÃO**

30W: 5-6H (100%)

60W: 9-10H (100%)

**MATERIAL**

Cast aluminium/PC/ABS

**CCT**

6000K (Optional)

**ÂNGULO DE FEIXE**

120°

**TAMANHO**

30W: 312\*230\*334mm

60W: 312\*230\*334mm

**ATRÁS**



**( BATERIA FIXA )**

**CARACTERÍSTICAS**



Rotativo



Gancho



Tripé



# volt



↑ Totalmete expandido ↓



↑ Armazenamento dobrável ↓



## SÉRIES VOLT

### VOLT-120W

- 3\*40W
- 16000LM/20000LM(BOOST)
- IP65

RA

70

USB OUTPUT

5V, 2A

BATERIA

19.2V 6.0Ah 6000mAh 115.2Wh

LiFePO4

TEMPO DE RECARGA

1.5-2H(21.6V 4A)

MODO DE TRABALHO

20%-40%-60%-80%-100%

Swieth:ON/OFF

TEMPO DE DURAÇÃO

2 battery:80min(100%) -7H(20%)

MATERIAL

Cast aluminium/PC/ABS

CCT

5000K(Optional)

ÂNGULO DE FEIXE

120°

TAMANHO

711\*351\*220mm(stored),

High:2m(use)



Mode A

360° lighting



Mode B

Area lighting



Mode B

One-way lighting



Adjustable lamp head



# RAYBOT

## SÉRIES RAYBOT

### RAYBOT

-  80W
-  10000LM
-  IP65

RA

70

USB output

5V, 2A

BATERIA

192. 2V 6. 0Ah LiFeP04

TEMPO DE RECARGA

1. 5-2H (21. 6V/4A/AC PACK)

MODO DE TRABALHO

Brightness Switch:

20%-40%-60%-80%-100%

Main Switch:

ON-OFF

TEMPO DE DURAÇÃO

80W: 2H (100%) / 10H (20%)

MATERIAL

Cast aluminium/PC/ABS

CCT

5000K (Optional)

ÂNGULO DE FEIXE

120°

TAMANHO

240\*250\*235mm

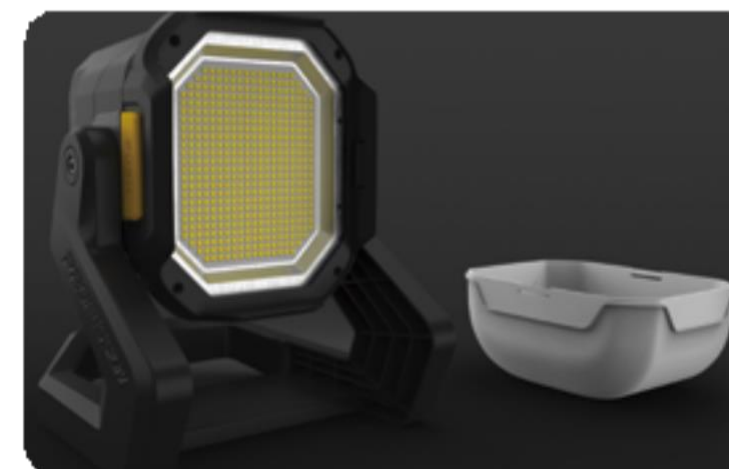

iluminação 360° e modo de iluminação unidirecional

livremente comutável (abajur removível)



Ganchos



Suporte Portátil



Projetores holofotes 360°  
(montado em tripé)



O fundo pode ser sugado magneticamente

luzes de projeto de iluminação de engenharia de área 360°



# REATOR-C



## REATOR-C 700W/300W

**P** 700W/300W  
**IP** À PROVA DE CHUVA

### Pico de energia

1200W/600W

### Potência

700W/300W

### AC Output

2x220V/1x220V

### DC Output

USB-A1==5V/2.4A

USB-A2==QC18W

Tipo-c1==PD30W (Conecta tipo-c1 e USB-A2 ao mesmo tempo. Ambas as conexões são saída de 5V 2,4 )

Tipe-c2==PD100W (bi-direcional) Carregador de carro\*1 (12V 10A)

Carregamento sem fio superior de 15 W (somente carregamento sem fio de 700 W)

### Informações da bateria

700W:33140 Fosfato de ferro e lítio 3.2V 15000mAh 7S2P 672WH

300W:26700 Fosfato de ferro e lítio 3.2V 4000MAh 4S6P 307.2Wh

### Charging method

700W:6530 interface de

carregamento TYPE-

C (PD100W)

200W (carregamento AC/solar)

300W:5525 interface de carregamento

TIPO-C (PD100W)

200W (carregamento AC/solar)

### Tamanho

700W:270x265x193mm

300W:260x285x173mm

### Peso

700W:7.1KG

300W:4.1KG





# séries 2040



## L10-2040-40W

- 40W
- 4000LM
- IP65
- 4H/BATERIA

### Tamanho

234. 5\*178. 5\*284MM

### Peso

3885g

### Ângulo de feixe

60°

### CCT

Optional

### Accessório

Entrada AC 100-240V, carregador de saída DC 25. 2V

### Bateria

1 ou 2 baterias

(capacidade de cada bateria:22. 2V, 4. 4Ah ou 5. 2Ah)

### Modo de trabalho

100%-50%-OFF

### Indicador da bateria

5 níveis indicadores  
verde/verde/verde/âmbar  
(amarelado)/vermelho

### Proteção da bateria

proteção contra sobrecarga e descarga excessiva e  
proteção contra altas temperaturas(70°C)



## SÉRIES 2040



## L10-2040-20W

- 40W
- 4000LM
- IP65
- 4H/BATERIA

### Tamanho

234. 5\*178. 5\*284MM

### Peso

3885g

### Ângulo de feixe

60°

### CCT

Optional

### Accessório

Entrada AC 100-240V, carregador de saída DC 25. 2V

### Bateria

1 ou 2 baterias

(capacidade de cada bateria:22. 2V, 4. 4Ah ou 5. 2Ah)

### Modo de trabalho

100%-50%-OFF

### Battery Indicador da bateria

5 níveis indicadores  
verde/verde/verde/âmbar  
(amarelado)/vermelho

### Proteção da bateria

proteção contra sobrecarga e descarga excessiva e  
proteção contra altas temperaturas(70°C)



# Séries G2040



## L10-G2040-40W

- 40W
- 4000LM
- IP65
- 4H/BATERIA

### Tamanho

232\*212\*365MM

### Peso

3110g

### Ângulo de feixe

60°

### CCT

Opcional

### Acessórios

Entrada AC 100-240V, carregador de saída DC 25.2V

### Bateria

1 ou 2 baterias

(capacidade de cada bateria:22.2V, 4.4Ah or 5.2Ah)

### Modo de trabalho

100%-50%-OFF

### Indicator da bateria

5 níveis indicadores

verde/verde/verde/âmbar

(amarelado)/vermelho

### Proteção da bateria

proteção contra sobrecarga e descarga excessiva e  
proteção contra altas temperaturas(70°C)

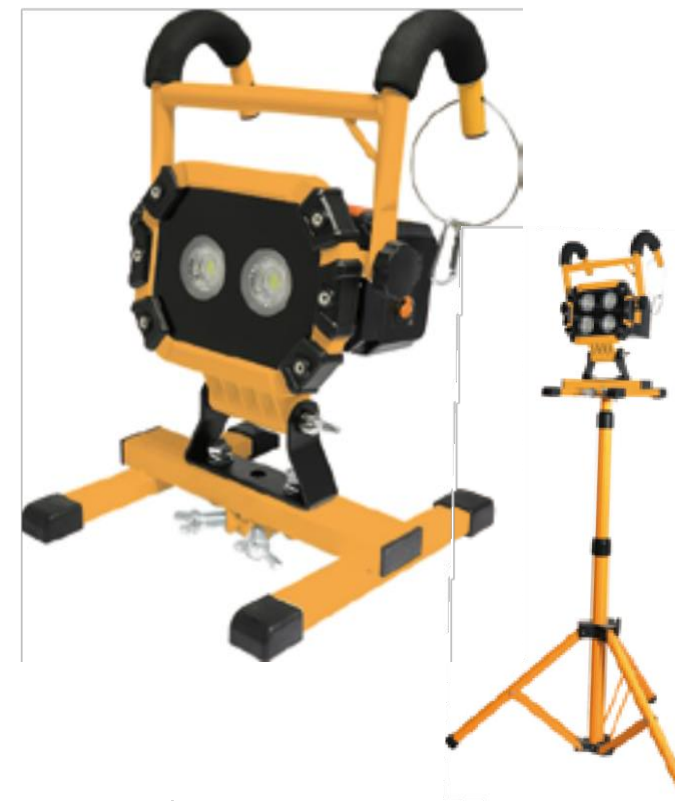

## SÉRIES G2040



## L10-G2040-20W

- 20W
- 2000LM
- IP65
- 4H/BATERIA

### Tamanho

232\*212\*365MM

### Peso

3110g

### Ângulo de feixe

60°

### CCT

Opcional

### Acessórios

Entrada AC 100-240V, carregador de saída DC 25.2V

### Bateria

1 ou 2 baterias

(capacidade de cada bateria:22.2V, 4.4Ah or 5.2Ah)

### Modo de trabalho

100%-50%-OFF

### Indicator da bateria

5 níveis indicadores

verde/verde/verde/âmbar

(amarelado)/vermelho

### Proteção da bateria

proteção contra sobrecarga e descarga excessiva e  
proteção contra altas temperaturas(70°C)





## L10-HBD2040-40W

**P** 40W

**IP** IP65

**Lúmen**  
5000LM

**Tamanho**  
235\*179\*284MM

**Peso**  
3550g

**Tensão de entrada**  
100-240V, 50/60Hz

**Ângulo de feixe**  
60°

**CCT**  
Optional  
RA

70

**RF**  
>0.9

**Proteção contra surtos**  
1KV-2KV

**Modo de trabalho**

Plug-in:ON/Plug-out:OFF

**DC(Opcional)**

Fonte de energia: Bateria ou sem bateria, mas multi-adaptador (TJ-41/TU-31) para bateria de energia

Modo de trabalho:100%-50%-OFF



## L10-HBDG2040-40W

**P** 40W

**IP** IP65

**Lúmen**  
5000LM

**Tamanho**  
235\*179\*284MM

**Peso**  
3800g

**Tensão de entrada**  
100-240V, 50/60Hz

**Ângulo de feixe**  
60°

**CCT**  
Opcional  
RA

70

**RF**  
>0.9

**Proteção contra surtos**  
1KV-2KV

**Modo de trabalho**

Plug-in:ON/Plug-out:OFF

**DC(Opcional)**

Lumen:5000LM

Fonte de energia:

Bateria ou sem bateria, mas multi-adaptador (TJ-41/TU-31) para bateria de energia

Modo de trabalho:100%-50%-OFF





# LUZ DO SITE PRO AREA 360



# LUZ DO SITE 360

## L13-2002

- 45W
- 6000LM
- IP65
- 4H(ENERGIA TOTAL)
- Tamanho**  
170\*170\*277MM
- Peso**  
3600g RA
- 70
- Bateria**  
14. 8V/10. 4Ah
- Material**  
Cast aluminium
- CCT**  
Optional
- Modo de trabalho** 100%-  
50%-15%-OFF





## L13-2003

- 40W
- 4000LM
- IP65
- 4H/BATERIA

### Tamanho

94\*299MM

### GCT

5000K-6000K (Opcional)

### Acessórios

Entrada AC 100-240V, adaptador de saída DC 12V/1A

### Ímã & Gancho

Ímã e gancho na parte inferior

Alça de PC com tampa de borracha e anel de borracha

À prova de choque

Indicador de energia

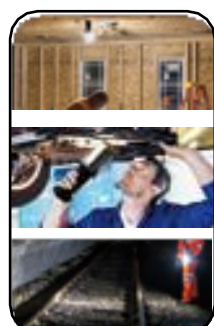

Luz 360°

Luz de tarefa

Tocha

Multifuncional



Gancho & Ímã

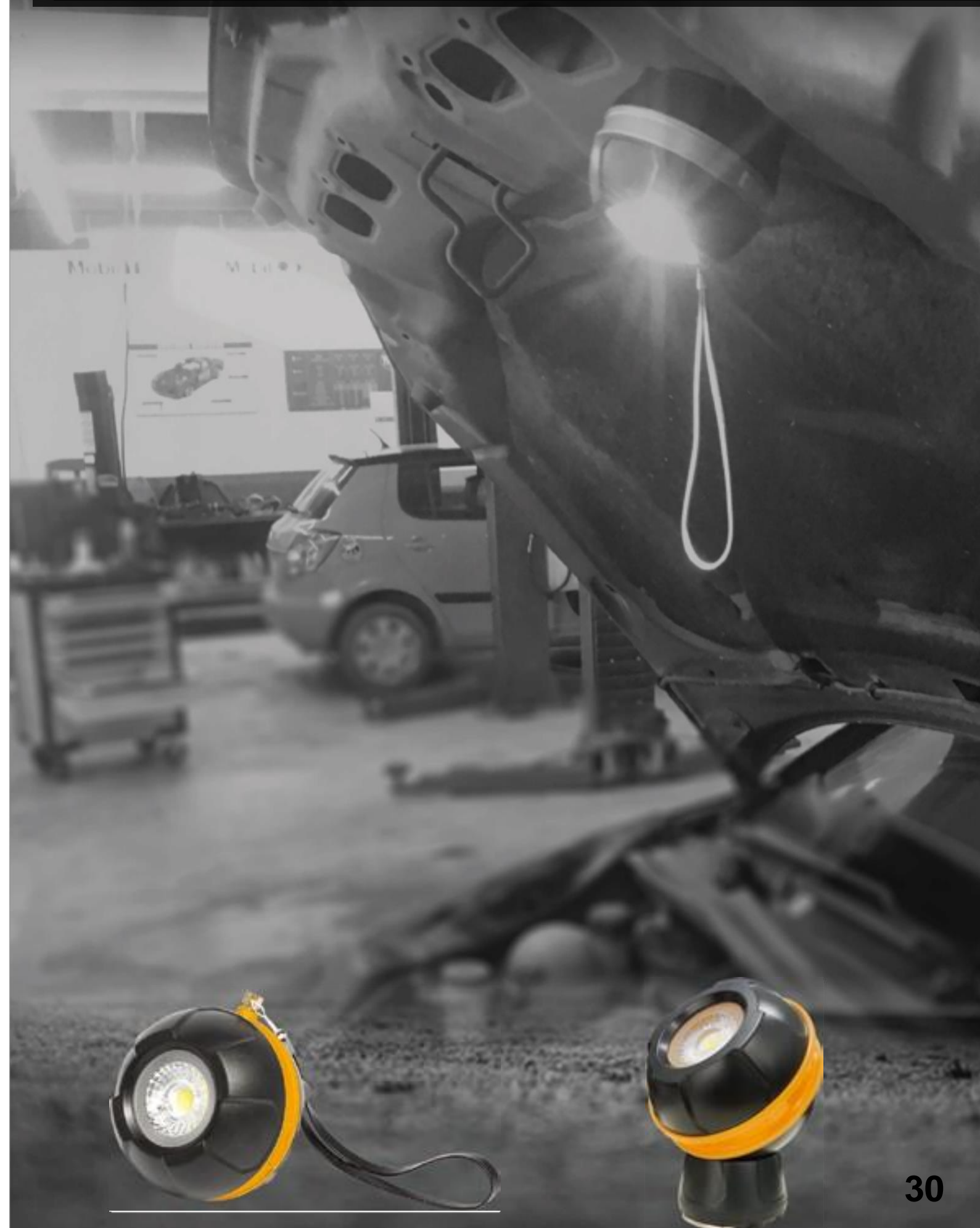



## LUZ DE TAREFA PORTÁTIL



### L13-2008C-W

- 5W
- 600LM
- IP44
- 4-5H(5V/1A)

**Tamanho**  
φ82\*65MM

**Peso**  
267g

**CCT**

Optional

**Acessório**

USB cable

**Bateria**

3.7V/4000mAh

**Modo de trabalho**

High-Low-SOS-Flash-OFF

**Indicador da bateria**

Há 4 peças de indicadores de baterias

**Proteção da bateria**

Proteção contra sobrecarga e descarga excessiva

**Tempo de duração**

Alto:3H/Baixo:6H

**Feixe**

60°



Porca 1/4

Indicador de Bateria



Carregador USB

Saída USB

Ímã

100%-50%-SOS-Brilho-OFF

### Opcional

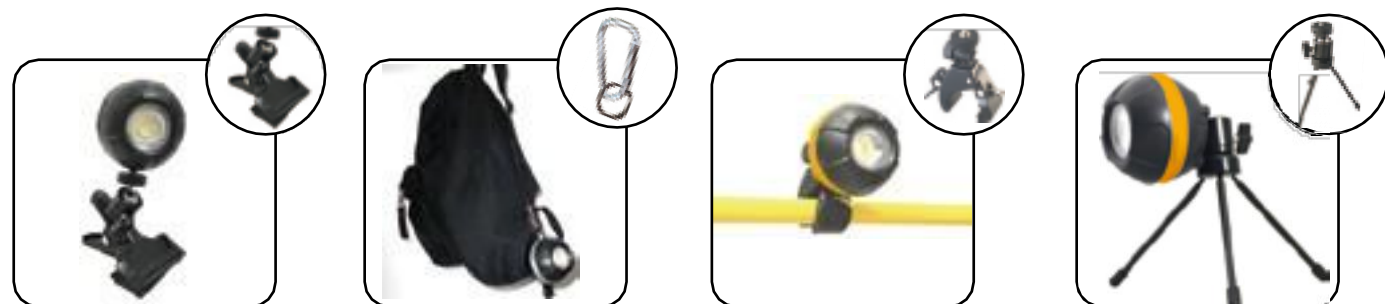

### L01-2009C-W

- 5W
- 600LM
- IP44
- 5-6H(5V/1A)

**Tamanho**

φ89\*106.5MM

**Peso**

420g(base magnética incluída)

**CCT**

Optional

**Acessório**

USB cable

**Bateria**

3.7V/4000mAh

**Modo de Trabalho**

High-Low-SOS-OFF

**Ângulo de feixe**

60°

**Proteção da bateria**

Over-charging and over-discharging protection

**Tempo de duração**

Alto:3H/Baixo:6H

## LUZ DE TAREFA PORTÁTIL



Anel de borracha (fluorescente)



USB



Ímã & Gancho

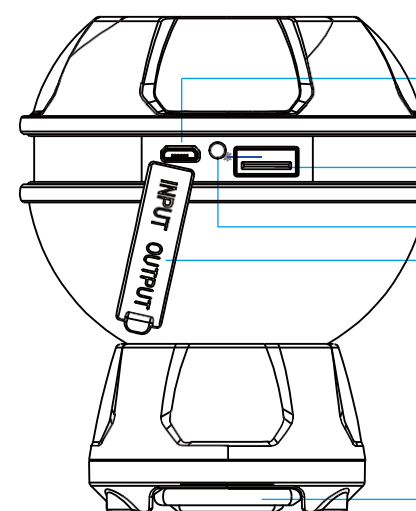

Entrada USB

Anel de borracha

(Fluorescente) Saída USB

Indicador de bateria

Borracha indicadora

Gancho

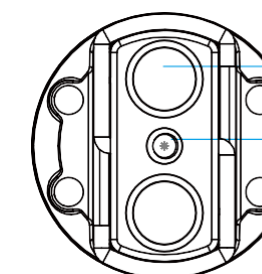

Borracha magnética

Porca 1/4